

FOOD SHIELD MODEL GUIDE

CHOICE ADJUSTABLE FOOD SHIELDS.....1	
1GUARD SELF SERVICE SNEEZE GUARDS.....2	
1GUARD FULL SERVICE DISPLAYS.....3	
1GUARD DUAL SERVICE.....4	
INFINITY UV BONDED FRAMLESS.....5	
FIXED GUARD POST OPTIONS.....6	

Specifications for reference only and may be changed without notice. All orders require approved shop drawings prior to release to production. Products are drawn & built to meet NSF Standard 2. It is the responsibility of the customer to ensure product meets local health board standards.

Web: www.pmg-inc.com
 Email: info@pmg-inc.com
 Phone: 1-800-251-5800
 Fax: 1-800-251-2515

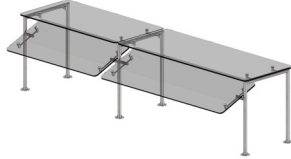
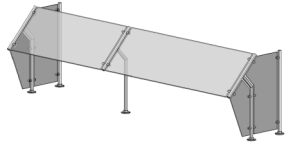
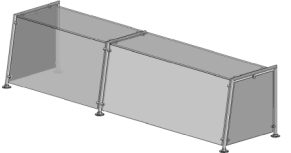
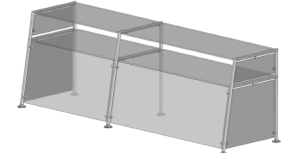
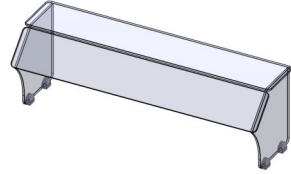
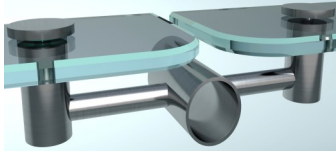

Printed in the USA (01/2016)
 Premier Metal & Glass Ventures, Inc.
 1835 MacArthur Blvd., NW
 Atlanta, Ga 30318



CHOICE™

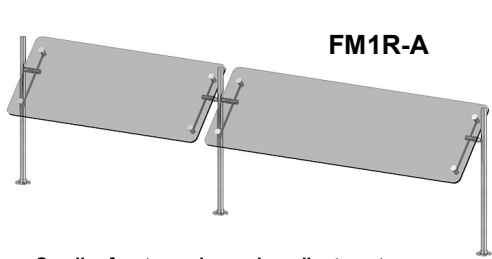

FM1R-A

Adjustable Guards Without Top Shelves

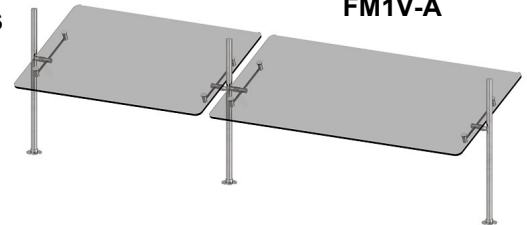

FM1V-A

Smaller front panel = easier adjustment

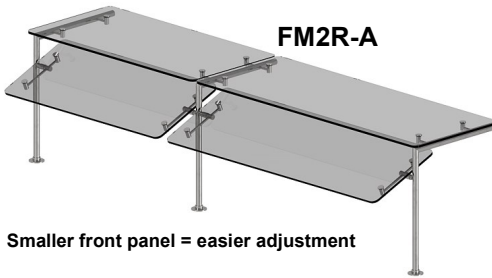

FM2R-A

Adjustable Guards With Top Shelves

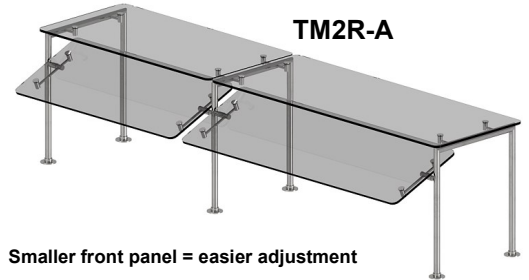

TM2R-A

Smaller front panel = easier adjustment

Smaller front panel = easier adjustment

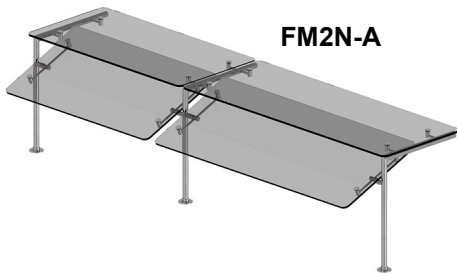

FM2N-A

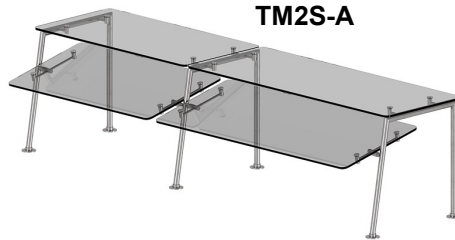

TM2S-A

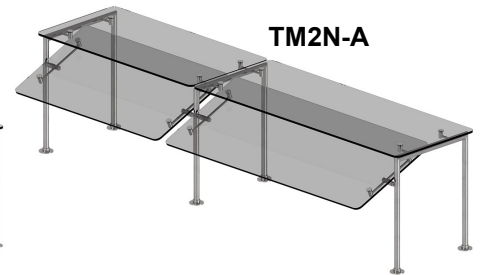

TM2N-A

Two Tier Adjustable Guard

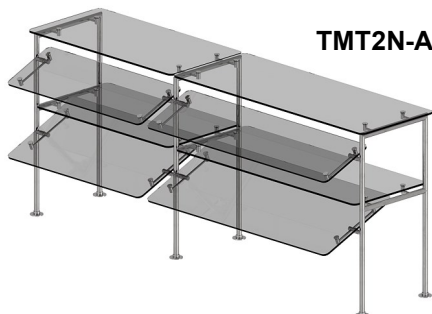

TMT2N-A

Double Sided Adjustable Guard

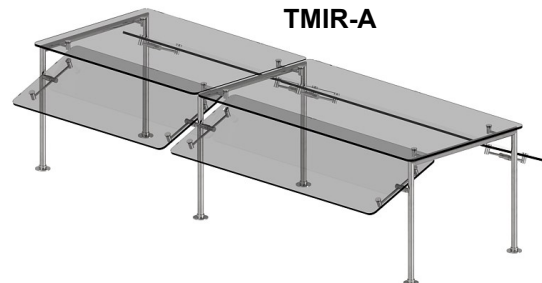

TMIR-A

Specifications for reference only and may be changed without notice. All orders require approved shop drawings prior to release to production. Products are drawn & built to meet NSF Standard 2. It is the responsibility of the customer to ensure product meets local health board standards.

Web: www.pmg-inc.com
Email: info@pmg-inc.com
Phone: 1-800-251-5800
Fax: 1-800-251-2515



Printed in the USA (01/2016)
Premier Metal & Glass Ventures, Inc.
1835 MacArthur Blvd., NW
Atlanta, Ga 30318

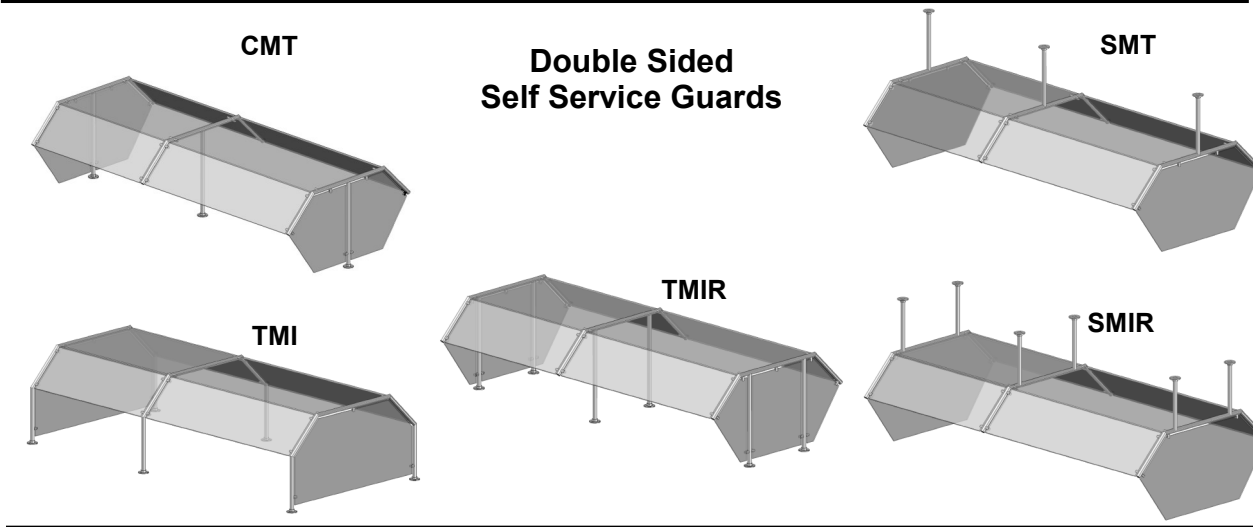
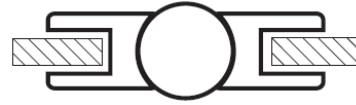

Specifications for reference only and may be changed without notice. All orders require approved shop drawings prior to release to production. Products are drawn & built to meet NSF Standard 2. It is the responsibility of the customer to ensure product meets local health board standards.

Web: www.pmg-inc.com
 Email: info@pmg-inc.com
 Phone: 1-800-251-5800
 Fax: 1-800-251-2515



Printed in the USA (01/2016)
 Premier Metal & Glass Ventures, Inc.
 1835 MacArthur Blvd., NW
 Atlanta, Ga 30318



**Full Service Guards
Without Top Shelves**

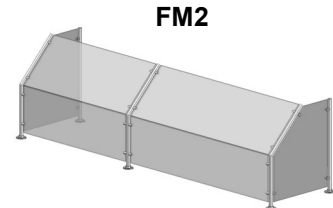
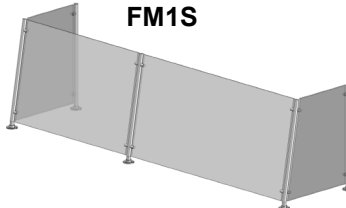
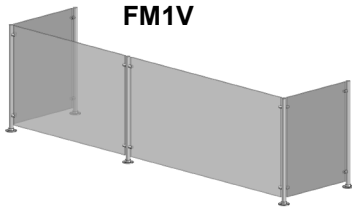

**Full Service Guards
With Top Shelves**

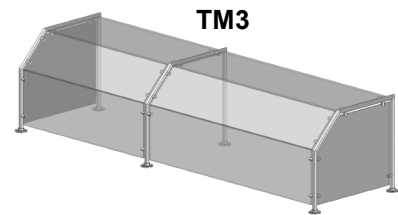
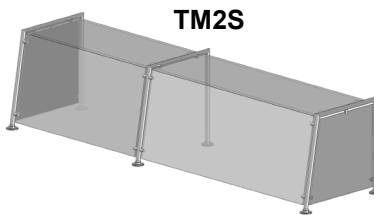
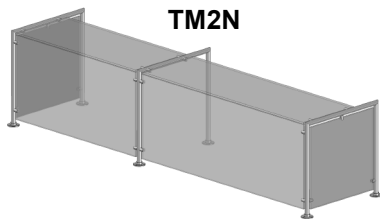

Where there's no room for a rear leg, use an FM model — Front Mounted post with under counter mounting option.

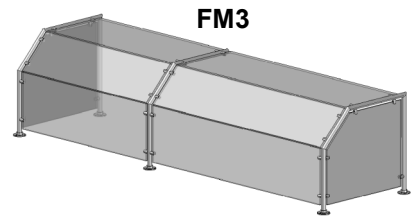
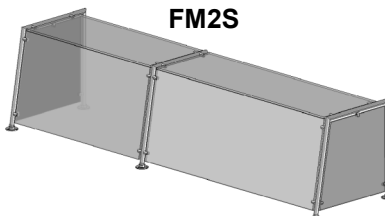
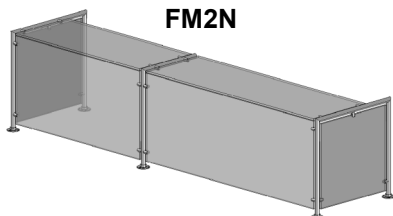

**Two Tiered
Full Service Guards**

Where there's no room for a rear leg, use an FM model — Front Mounted post with under counter mounting option.

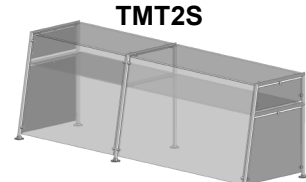
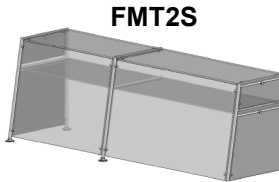
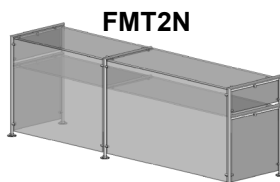
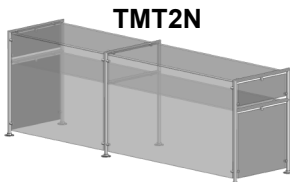

Specifications for reference only and may be changed without notice. All orders require approved shop drawings prior to release to production. Products are drawn & built to meet NSF Standard 2. It is the responsibility of the customer to ensure product meets local health board standards.

Web: www.pmg-inc.com
Email: info@pmg-inc.com
Phone: 1-800-251-5800
Fax: 1-800-251-2515



Printed in the USA (01/2016)
Premier Metal & Glass Ventures, Inc.
1835 MacArthur Blvd., NW
Atlanta, Ga 30318

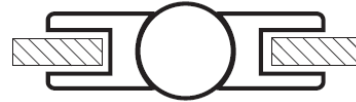

Two Tier Dual Service

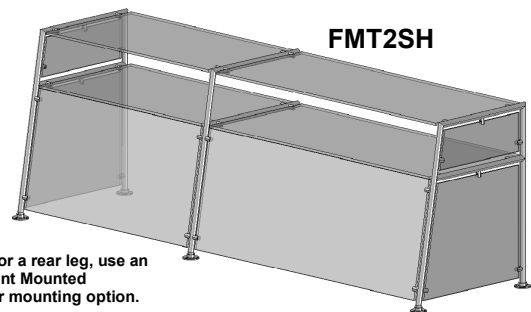
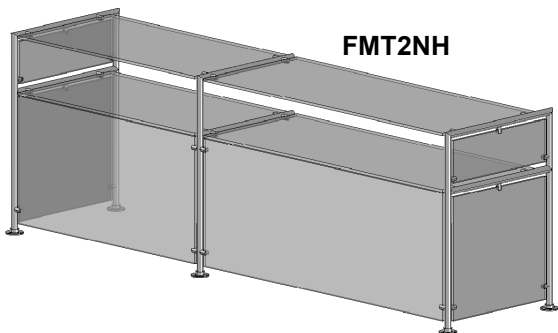
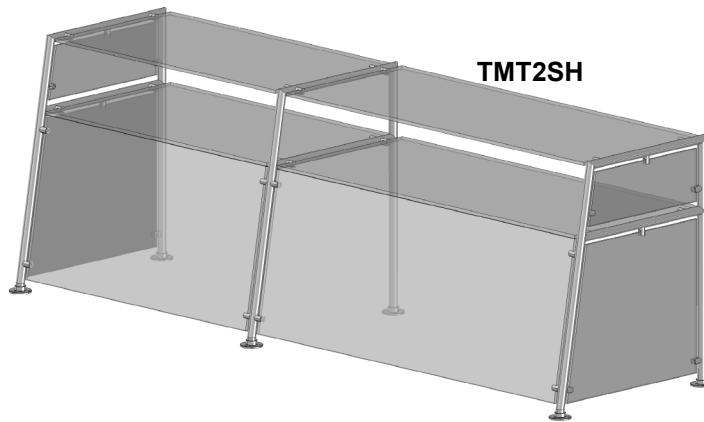
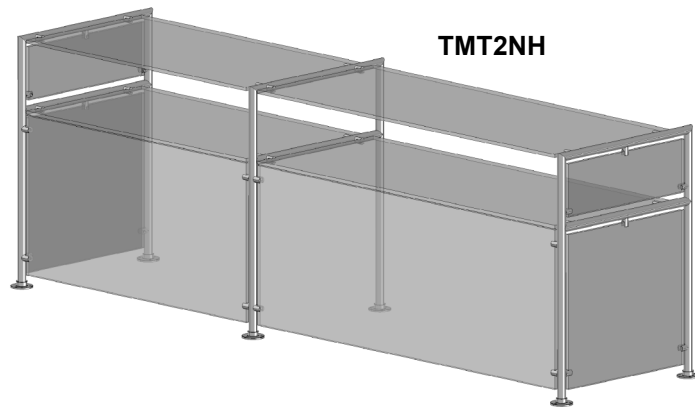

Where there's no room for a rear leg, use an FM model — Front Mounted post with under counter mounting option.

Specifications for reference only and may be changed without notice. All orders require approved shop drawings prior to release to production. Products are drawn & built to meet NSF Standard 2. It is the responsibility of the customer to ensure product meets local health board standards.

Web: www.pmg-inc.com
 Email: info@pmg-inc.com
 Phone: 1-800-251-5800
 Fax: 1-800-251-2515



Printed in the USA (01/2016)
 Premier Metal & Glass Ventures,
 Inc.
 1835 MacArthur Blvd., NW



Standard models shown below.
Please let us know if you have a design or concept not shown.
Lights and heat available.

Full Service Displays

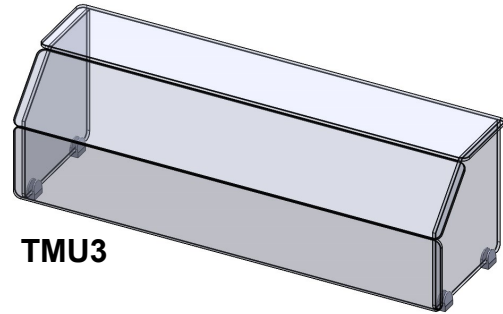
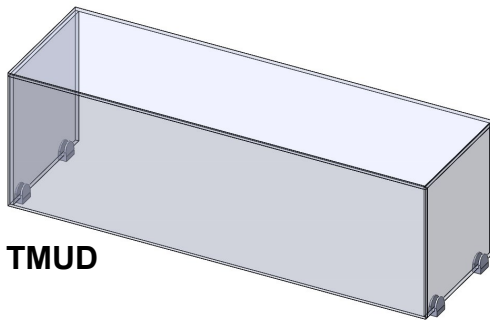

Self-Service Sneeze Guards

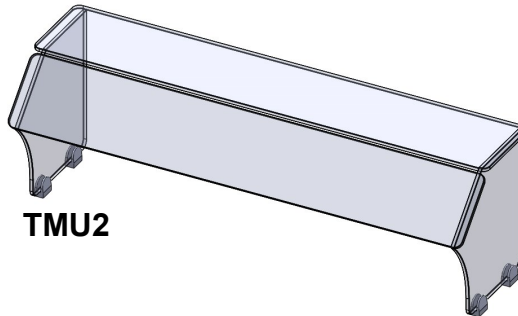
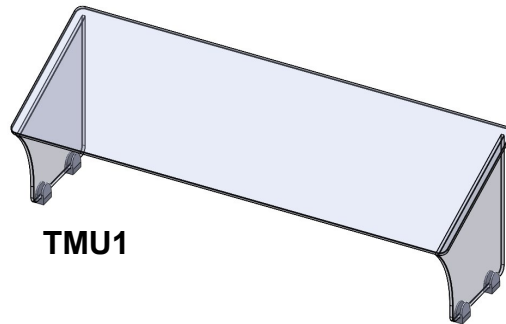
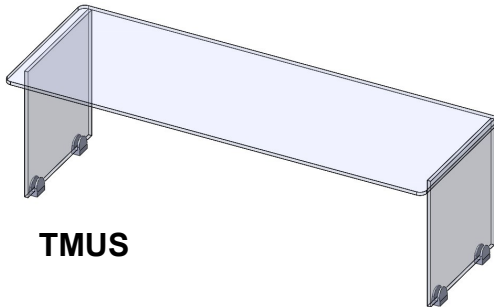

Specifications for reference only and may be changed without notice. All orders require approved shop drawings prior to release to production. Products are drawn & built to meet NSF Standard 2. It is the responsibility of the customer to ensure product meets local health board standards.

Web: www.pmg-inc.com
Email: info@pmg-inc.com
Phone: 1-800-251-5800
Fax: 1-800-251-2515



Printed in the USA (01/2016)
Premier Metal & Glass Ventures, Inc.
1835 MacArthur Blvd., NW
Atlanta, Ga 30318

Nearly all of Premier's non-adjustable, fixed guard models available with post styles and post to glass connections depicted below.

Stainless Post Options

Option 1

1GUARD™

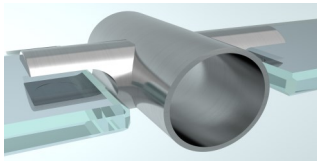

1Guard with welded glass clips depicted here.

Option 2

FUSION™

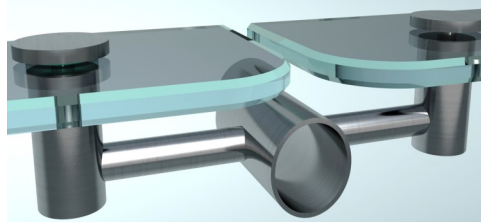
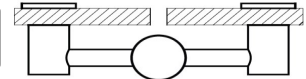

Fusion with welded standoffs and through glass connections depicted here.

1GUARD™ and Fusion™ Supports:

- 1" OD Stainless Steel
- Contact factory for additional tubing options

Glass Options:

- 1/4" Glass - 48" max. Span
 - 3/8" Glass - 60" max. Span
- Contact factory for spans exceeding max.

NSF Listed Stainless Post Finishes:

- Brushed (#4) Stainless
 - Polished (#8) Stainless
 - Flat Black
 - Wrinkle Black
 - Unlimited Powder Coats, specify:
RAL#: _____
- Some finish/tubing combinations are not recommended.

Brass Post Options

Option 3

ChannelTube™

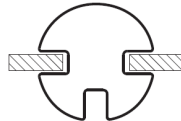

2" OD Brass Support

ChannelTube with internalized glass channel depicted here.

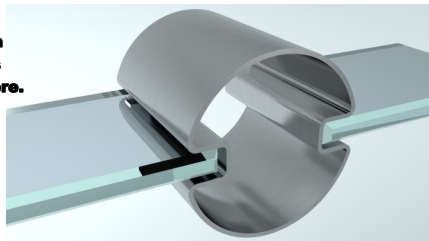

Option 4

PanelTube™

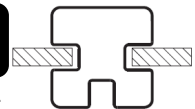

1-1/2" Square Brass Support

PanelTube with internalized glass channel depicted here.

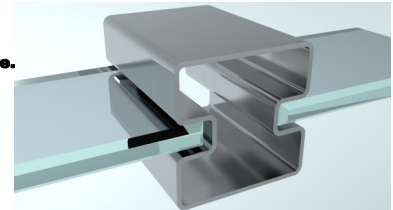

Both ChannelTube™ and PanelTube™ utilize internal channel construction.

Eliminate traditional clunky glass clips and channel applied to the tube's exterior.

Glass Option:

Internal Channels Accommodate 1/4" Glass with 48" Maximum Spans
Contact factory for spans exceeding max.

NSF Listed Brass Post Finishes

- Satin OR Polished Brass
 - Satin OR Polished Chrome Plating
 - Unlimited Powder Coats, specify:
RAL#: _____
- Some finish/tubing combinations are not recommended.
Contact factory for samples or additional information.

Specifications for reference only and may be changed without notice. All orders require approved shop drawings prior to release to production. Products are drawn & built to meet NSF Standard 2. It is the responsibility of the customer to ensure product meets local health board standards.

Web: www.pmg-inc.com
Email: info@pmg-inc.com
Phone: 1-800-251-5800
Fax: 1-800-251-2515



Printed in the USA (01/2016)
Premier Metal & Glass Ventures, Inc.
1835 MacArthur Blvd., NW
Atlanta, Ga 30318